

Attention à la présence et la position du ®. (inclus ou non dans l'hexagone du logo, sur 1 seule face...etc)

A

	<p>Société CENISUCRE 53 Rue de Crimée MARSEILLE</p>
--	--

A-200
80x 55-S

--	--

A-201
80x 55-S

<p>Assistance Publique</p> <p>Hôpitaux de Paris</p>	<p>Société CENISUCRE 42 Bis, Bd Guigou tel. 502521 MARSEILLE</p>
---	---

A-202
80x 55-S

<p>cafés</p>	
--------------	--

A-204
60x 55-S

<p>CAFÉS</p>	
--------------	--

A-205
60x 55-S

<p>CAFÉS</p>	
--------------	--

A-206
60x 55-S

<p>Cafés <i>Bondin</i></p>	
--------------------------------	--

Rouge

B-205
60x 55-S

B

<p>café BIBAL</p>	
-----------------------	--

Marron

B-200
60x 55-S

<p>café BIBAL</p>	
-----------------------	--

B-220
60x 55-S

C

--	--

Noir

B-202
60x 55-S

	<p>CANNES</p> <p>HOTEL PALACE CANNES</p>
--	--

Bleu

C-201
60x 55-S

<p>Cafés <i>Bondin</i></p>	
--------------------------------	--

Marron

B-203
60x 55-S

				<p>Société CENISUCRE 53 Rue de Crimée MARSEILLE</p>
--	--	--	--	--

C-205
80x 55-S

J'ai bordeaux et doré. Cherche autres couleurs

<p>Cafés <i>Bondin</i></p>	
--------------------------------	--

Orange

B-204
60x 55-S

				<p>CONTENANCE</p> <p>MORCEAU DE SUCRE</p> <p>2</p> <p>CENISUCRE 53 RUE DE CRIMÉE M. L. 08542 MARSEILLE</p>
--	--	--	--	--

C-206
80x 55-S

<p>SACHETS CENISUCRE</p>	<p>Société CENISUCRE 53 Rue de Crimée tel. 506540 MARSEILLE</p>
<p>C-207 80x55-S</p>	

<p>CENISUCRE</p>	<p>CENISUCRE</p>
<p>Marron</p> <p>C-219 60x55-S (sans ®)</p>	

	<p>CENISUCRE</p>
<p>Noir</p> <p>C-229 60x55-S</p>	

<p>Rouge</p> <p>C-210 60x55-S</p>	

<p>CENISUCRE</p>	<p>CENISUCRE</p>
<p>Rouge</p> <p>C-220 60x55-S (sans ®)</p>	

<p>Vert</p> <p>C-230 60x55-S</p>	

<p>Rouge</p> <p>C-216 60x55-S</p>	

<p>1 sucre</p>	<p>1 sucre</p>
<p>Vert</p> <p>C-221 60x55-S</p>	

<p>C-237 60x55-S</p>	

<p>Noir</p> <p>C-217 60x55-S</p>	



<p>CO.D.E.CO UN PLUS dans la distribution automatique ☎ (1) 43 39 07 46</p>	
<p>Marron</p> <p>C-225 60x55-S</p>	

<p>CAFE Plus</p>	
<p>Rouge</p> <p>C-238 60x55-S</p>	

<p>CENISUCRE</p>	<p>CENISUCRE</p>
<p>Violet</p> <p>C-218 60x55-S (sans ®)</p>	



	<p>1 sucre</p>
<p>Bleu</p> <p>C-228 60x55-S</p>	

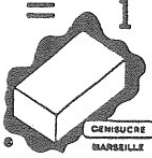

	<p>sucre semole surchoix</p> <p>CENISUCRE marseille</p>
<p>C-241 65x45-S</p>	

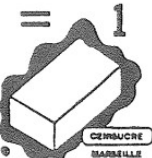
	
Noir	
C-244 60x55-S	



	
Vert	
D-203 60x55-S	

	
Marron	
E-209 60x55-S	

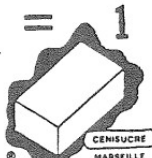

	
C-252 60x55-S	



	
Impression orange	
D-206 60x55-S voir série D11/3	

F	
	
Orange	
F-202 60x55-S	



	
C-255 60x55-S	

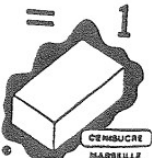

	
D-210 60x55-S	

	
Marron	
F-205 60x55-S	

	
C-262 60x55-S	

E	
	
Rouge	
E-205 60x55-S	

	
Rouge	
F-206 60x55-S	

	
C-265 80x55-S	

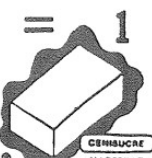
	
Bleu	
E-208 60x55-S	

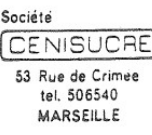
	
F-207 80x55-S	

D	
----------	--

<p>Epicerie en gros Ets. CHARLES FODÉRE</p> <p>9 Quai VICTOR AUGAGNEUR LYON Tel. 002382</p>	<p>Société CENISUCRE</p> <p>53 Rue de Crimée MARSEILLE</p>
<p>F-208 80x55-S</p>	

<p>I</p>	
	<p>CENISUCRE</p> <p>25, Boulevard Massenet MARSEILLE Tél. 91.60.68.40</p>
<p>I-210 60x55-S</p>	

<p>ETS. R. KOCH S.A. CONCESSIONNAIRE MIKO</p> <p>PRODUITS SURGELÉS DE QUALITÉ</p> <p>COLMAR - TEL. 414565</p>	<p>CONTENANCE</p> <p>CENISUCRE</p> <p>53 RUE DE CRIMÉE TEL. 91.60.68.40 MARSEILLE</p>
<p>M-206 80x55-S</p>	

<p>FOUNTAIN ROUSSILLON</p> <p>1, Rue des Ecoles 66540 BAHO Tél : 68.38.07.09</p>	<p>CENISUCRE</p> <p>EGALE UN SUCRE</p> <p>Marron</p>
<p>F-215 60x55-S</p>	

<p>L</p>	
<p>L'Égyle</p> <p>101 Cours J. Jaures Tel. 96 19 94 GRENOBLE</p>	<p>Société CENISUCRE</p> <p>53 Rue de Crimée MARSEILLE</p>
<p>L-200 80x55-S</p>	

<p>ETS. R. KOCH S.A. CONCESSIONNAIRE MIKO</p> <p>PRESTIGE DE LA FRANCE 1971</p> <p>COLMAR - TEL. 414585</p>	<p>CONTENANCE</p> <p>CENISUCRE</p> <p>MORCEAUX DE SUCRE</p> <p>53 RUE DE CRIMÉE TEL. 91.60.68.40 MARSEILLE</p>
<p>M-207 80x55-S</p>	

<p>G</p>	
	<p>CENISUCRE</p> <p>EGALE UN SUCRE</p> <p>Marron</p>
<p>G-209 60x55-S</p> <p>La gamelle ? La griselle ?</p>	

<p>M</p>	
	<p>CENISUCRE</p> <p>42 bis, Boulevard Guigou Tel 602621 MARSEILLE</p>
<p>M-200 80x55-S</p>	

<p>CAFÉS MICHEL</p> <p>33600 PESSAC Tél. 56.36.93.32</p>	<p>CENISUCRE</p> <p>25, Boulevard Massenet MARSEILLE Tél. 91.60.68.40</p>
<p>M-213 60x55-S</p>	

<p>H</p>	
<p>les in-com-pa-rables</p> <p>CAFÉS</p> <p>HENRI</p> <p>83 - La Valette - du - Var Tél. 93.10.87</p>	<p>sucré surchoix en...</p> <p>SACHETS</p> <p>CENISUCRE</p> <p>53 Rue de Crimée Tel. 506540 MARSEILLE</p>
<p>H-200 80x55-S</p>	

	<p>sucré surchoix en...</p> <p>SACHETS</p> <p>CENISUCRE</p> <p>53 Rue de Crimée MARSEILLE</p>
<p>M-201 80x55-S</p>	

<p>N</p>	
<p>New York CITY</p> <p>Club Discotheque</p> <p>Agence à BANCY de LA NANTES INDISPENSABLE POUR TOUS COURT ET LONGS LEJOURS DES SPECTACLES TOUTE L'ANNÉE LE PRIX ABORDABLE - PAS CHANGER RECHERCHER MINIMUM</p>	<p>1 sucre</p> <p>CENISUCRE</p> <p>53 RUE DE CRIMÉE TEL. 91.60.68.40 MARSEILLE</p>
<p>New York City N-200 60x55-S</p>	

<p>les in-com-pa-rables</p> <p>CAFÉS</p> <p>HENRI</p> <p>83 - La Valette - du - Var Tél. 98.04.12</p>	<p>sucré surchoix en...</p> <p>SACHETS</p> <p>CENISUCRE</p> <p>53 Rue de Crimée MARSEILLE</p>
<p>H-201 80x55-S</p>	

<p>CAFÉS MICHEL</p> <p>33600 PESSAC Tél. 56.36.93.32</p>	<p>= 1</p> <p>CENISUCRE MARSEILLE</p> <p>Marron</p>
<p>M-205 60x55-S</p>	

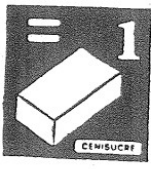

<p>NELLOU</p> <p>Brûlerie de CAFÉS Boutique de THÉ</p> <p>8, rue de la Corniche Tél. 20 25 70 - 40740164</p>	<p>CENISUCRE</p> <p>EGALE UN SUCRE</p> <p>Rouge</p>
<p>N-201 60x55-S</p>	

R

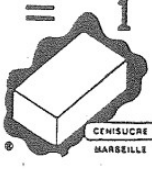

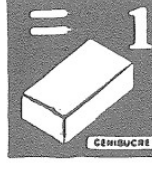
 <p>Relais votre étape sur l'autoroute</p>	 <p>CENISUCRE MARSEILLE</p>
<p>Rouge</p> <p>R-200 60x55-S</p>	

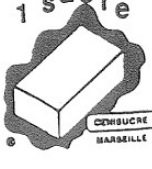

 <p>SODEXHO RESTAURATION ET SERVICES</p>	 <p>CENISUCRE MARSEILLE</p>
<p>Rouge</p> <p>S-213 60x55-S</p>	

 <p>SODEXHO Gestion de Restaurants de collectivité</p> <p>MARSEILLE TEL. (01) 83 00 23 LYON TEL. (01) 233 00 78 NICE TEL. (03) 31 23 00 BREDADE TEL. (70) 54 00 00</p>	 <p>CENISUCRE</p>
<p>Marron</p> <p>S-224 60x55-S</p>	

 <p>Relais</p>	 <p>CENISUCRE MARSEILLE</p>
<p>Rouge</p> <p>R-204 60x55-S</p>	

 <p>SODEXHO Gestion de Restaurants de collectivité</p> <p>MARSEILLE TEL. (01) 83 00 23 LYON TEL. (01) 233 00 78 NICE TEL. (03) 31 23 00 BREDADE TEL. (70) 54 00 00</p>	 <p>CENISUCRE MARSEILLE</p>
<p>Bleu</p> <p>S-215 60x55-S</p>	



 <p>SOGERES Cote d'Azur</p>	 <p>CENISUCRE EGALE UN SUCRE</p>
<p>Bleu</p> <p>S-227 60x55-S</p>	

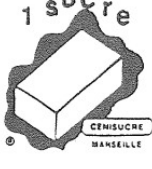

<p>DISTRIBUTION AUTOMATIQUE</p>  <p>Red D 42.55.37.90</p> <p>AGENCEMENTS COMPTOIRS DE BARS</p>	 <p>CENISUCRE EGALE UN SUCRE</p>
<p>Marron</p> <p>R-212 60x55-S</p>	



 <p>SODEXHO RESTAURATION ET SERVICES</p>	 <p>CENISUCRE MARSEILLE</p>
<p>Rouge</p> <p>S-216 60x55-S</p>	



 <p>Cafe VERNISSAT</p> <p>AVIGNON 4: Bd Clos des Trams Tel. 81.14.84</p>	<p>ociété</p> <p>CENISUCRE</p> <p>53 Rue de Crimée tel. 506540 MARSEILLE</p>
<p>Marron</p> <p>V-200 60x55-S</p>	

S

 <p>SHR RESTAURANT D'ENTREPRISE</p> <p>5,5 g de Sucre = 92 KJ (22 Calorie)</p>	 <p>CENISUCRE MARSEILLE</p>
<p>Marron</p> <p>S-208 60x55-S</p>	

 <p>5,5 g de sucre = 92 KJ (22 calories)</p>	 <p>CENISUCRE EGALE UN SUCRE</p>
<p>Bleu</p> <p>S-218 60x55-S</p>	

 <p>vign DISTRIBUTEURS AUTOMATIQUES</p> <p>Tél. 56.39.72.49</p>	 <p>CENISUCRE MARSEILLE</p>
<p>Marron</p> <p>V-202 60x55-S</p>	

 <p>5,5 g de sucre = 92 KJ (22 calories)</p>	 <p>CENISUCRE MARSEILLE</p>
<p>Rouge</p> <p>S-209 60x55-S</p>	

 <p>SMD distribution automatique</p> <p>Tél. 31.70.37.00 Fax: 31.04.1457</p>	<p>CENISUCRE</p> <p>25, Boulevard Massenet MARSEILLE</p> <p>Tél. 91.60.68.40</p>
<p>Marron</p> <p>S-223 60x55-S</p>	

**Et bien sûr, LES EMBALLAGES
NON REPERTORIES
MERCY**